

HANGING LAMP COLGANTE



MATERIAL: Opal glass and brass

MATERIAL: Vidrio opal y latón

LED  
E14 7W x 5 units

WEIGHT PESO: 10 KG  
Package size: 0,72 x 0,72 x 0,72

FINISHES  
ACABADOS

LAQUERED  
LACADOS



BLACK  
NEGRO



WHITE  
BLANCO



SLATE BLUE  
AZUL PIZARRA

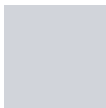

FOG BLUE  
AZUL NIEBLA



GREY GREEN  
VERDE GRIS



SOFT GREEN  
VERDE SOFT



BURGUNDY  
BORGOÑA



CORAL PINK  
ROSA CORAL



PASTEL BLUE  
AZUL PASTEL

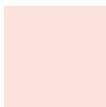

QUARTZ PINK  
ROSA QUARZO

FABRIC LAMPSHADE (OPTIONAL)  
PANTALLAS TEXTILES (OPCIONAL)



BLACK  
NEGRO



RED  
ROJO



WHITE  
BLANCO

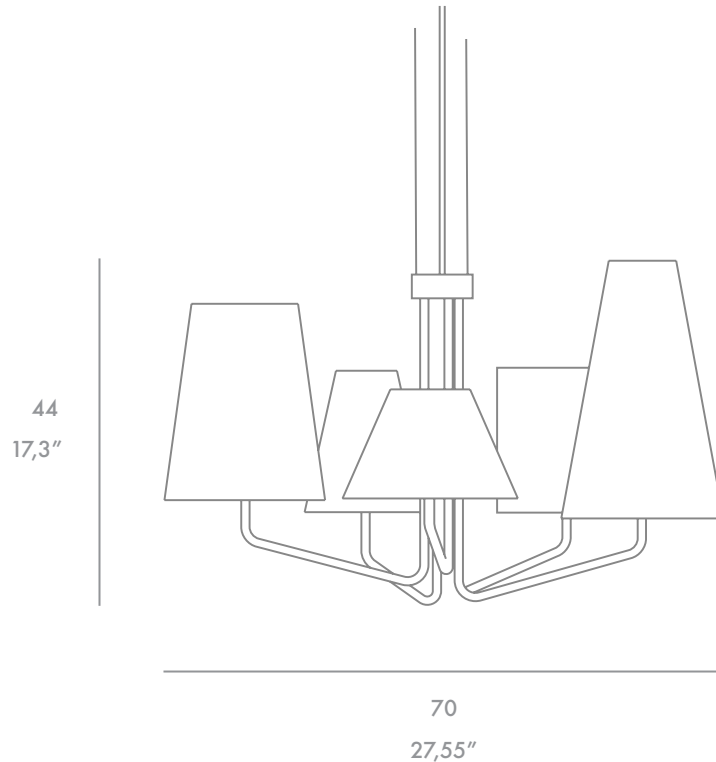

Lighting for domestic use.

Do not store or keep under extreme temperatures during long periods of time.

Do not handle the electrical material more than the necessary for installation of the fixture.

The installation must be done by specialized technical team.

Do not use bulbs with superior voltage as recommended by the manufacture.

For its cleaning, use only a soft cloth moistened with a mild soap solution. Do not use ammonia products, solvents or abrasives.

Do not use products such as air freshener that may contain alcoholic base.

Iluminación para uso doméstico.

No almacenar ni exponer a condiciones extremas de humedad o durante periodos prolongados.

No manipular el material eléctrico de la luminaria más allá del especificado para su montaje.

La instalación debe realizarse por personal técnico especializado.

No utilizar bombillas de potencia superior a la recomendada por el fabricante.

Para su limpieza, utilizar un paño suave ligeramente humedecido con una solución jabonosa.

No utilizar productos amoniacales, disolventes ni abrasivos. No pulverizar directamente, ni arrojar sobre la superficie productos ambientales y/o de base alcohólica.



HANGING LAMP COLGANTE

MATERIAL: Brass

MATERIAL: Latón

LED  
E14 7W x 7 units

WEIGHT PESO: 20 KG  
Package size: 1,14 x 1,14 x 0,73

FINISHES  
ACABADOS

LAQUERED  
LACADOS



BLACK  
NEGRO



WHITE  
BLANCO



SLATE BLUE  
AZUL PIZARRA

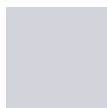

FOG BLUE  
AZUL NIEBLA



GREY GREEN  
VERDE GRIS



SOFT GREEN  
VERDE SOFT



BURGUNDY  
BORGOÑA



CORAL PINK  
ROSA CORAL



PASTEL BLUE  
AZUL PASTEL



QUARTZ PINK  
ROSA QUARZO

FABRIC LAMP SHADE (OPTIONAL)  
PANTALLAS TEXTILES (OPCIONAL)



BLACK  
NEGRO



RED  
ROJO



WHITE  
BLANCO

54  
21,3"

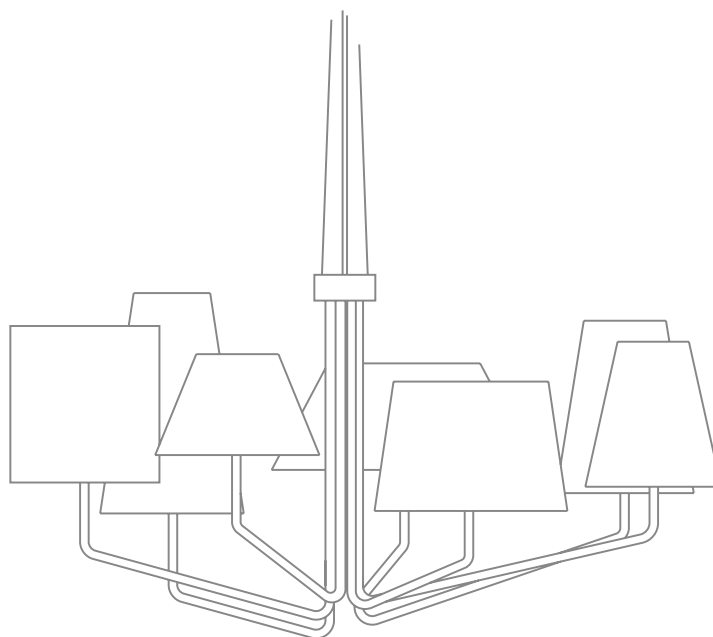

115  
45,3"

Lighting for domestic use.

Do not store or keep under extreme temperatures during long periods of time.

Do not handle the electrical material more than the necessary for installation of the fixture.

The installation must be done by specialized technical team.

Do not use bulbs with superior voltage as recommended by the manufacture.

For its cleaning, use only a soft cloth moistened with a mild soap solution. Do not use ammonia products, solvents or abrasives.

Do not use products such as air freshener that may contain alcoholic base.

Iluminación para uso doméstico.

No almacenar ni exponer a condiciones extremas de humedad o durante periodos prolongados.

No manipular el material eléctrico de la luminaria más allá del especificado para su montaje.

La instalación debe realizarse por personal técnico especializado.

No utilizar bombillas de potencia superior a la recomendada por el fabricante.

Para su limpieza, utilizar un paño suave ligeramente humedecido con una solución jabonosa.

No utilizar productos amoniacales, disolventes ni abrasivos. No pulverizar directamente, ni arrojar sobre la superficie productos ambientales y/o de base alcohólica.



TABLE LAMP SOBREMESA

MATERIAL: Brass

MATERIAL: Latón

LED  
E14 4W x 4 units

WEIGHT PESO: 3 KG  
Package size: 0,85 x 0,46 x 0,46

FINISHES  
ACABADOS

LAQUERED  
LACADOS



BLACK  
NEGRO



WHITE  
BLANCO



SLATE BLUE  
AZUL PIZARRA

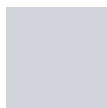

FOG BLUE  
AZUL NIEBLA



GREY GREEN  
VERDE GRIS



SOFT GREEN  
VERDE SOFT



BURGUNDY  
BORGOÑA



CORAL PINK  
ROSA CORAL



PASTEL BLUE  
AZUL PASTEL

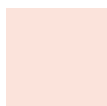

QUARTZ PINK  
ROSA QUARZO

METALLIC  
METÁLICOS



CHROME  
CROMADO



COPPER  
COBRE



GOLD  
ORO

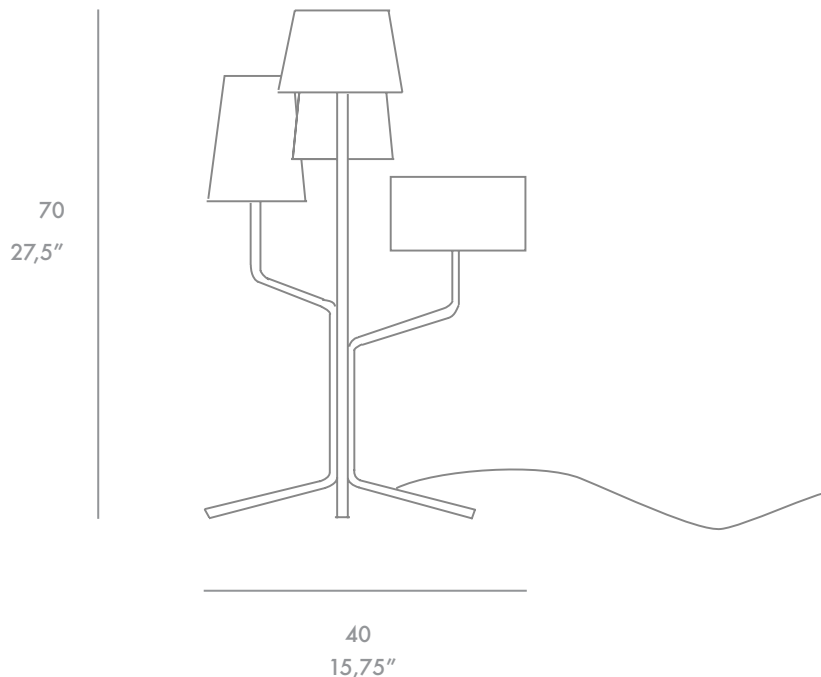

FABRIC LAMPSHADE (OPTIONAL)  
PANTALLAS TEXTILES (OPCIONAL)



BLACK  
NEGRO



RED  
ROJO



WHITE  
BLANCO

Lighting for domestic use.

Do not store or keep under extreme temperatures during long periods of time.

Do not handle the electrical material more than the necessary for installation of the fixture.

The installation must be done by specialized technical team.

Do not use bulbs with superior voltage as recommended by the manufacture.

For its cleaning, use only a soft cloth moistened with a mild soap solution. Do not use ammonia products, solvents or abrasives.

Do not use products such as air freshener that may contain alcoholic base.

Iluminación para uso doméstico.

No almacenar ni exponer a condiciones extremas de humedad o durante periodos prolongados.

No manipular el material eléctrico de la luminaria más allá del especificado para su montaje.

La instalación debe realizarse por personal técnico especializado.

No utilizar bombillas de potencia superior a la recomendada por el fabricante.

Para su limpieza, utilizar un paño suave ligeramente humedecido con una solución jabonosa.

No utilizar productos amoniacales, disolventes ni abrasivos. No pulverizar directamente, ni arrojar sobre la superficie productos ambientales y/o de base alcohólica.



FLOOR LAMP LÁMPARA DE PIE

MATERIAL: Brass

MATERIAL: Latón

LED  
E14 7W x 4 units

WEIGHT PESO: 10 KG  
Package size: 1,75 x 0,46 x 0,46

FINISHES  
ACABADOS

LAQUERED  
LACADOS



BLACK  
NEGRO



WHITE  
BLANCO



SLATE BLUE  
AZUL PIZARRA

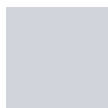

FOG BLUE  
AZUL NIEBLA



GREY GREEN  
VERDE GRIS



SOFT GREEN  
VERDE SOFT



BURGUNDY  
BORGOÑA



CORAL PINK  
ROSA CORAL



PASTEL BLUE  
AZUL PASTEL

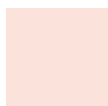

QUARTZ PINK  
ROSA QUARZO

METALLIC  
METÁLICOS



CHROME  
CROMADO



COPPER  
COBRE



GOLD  
ORO

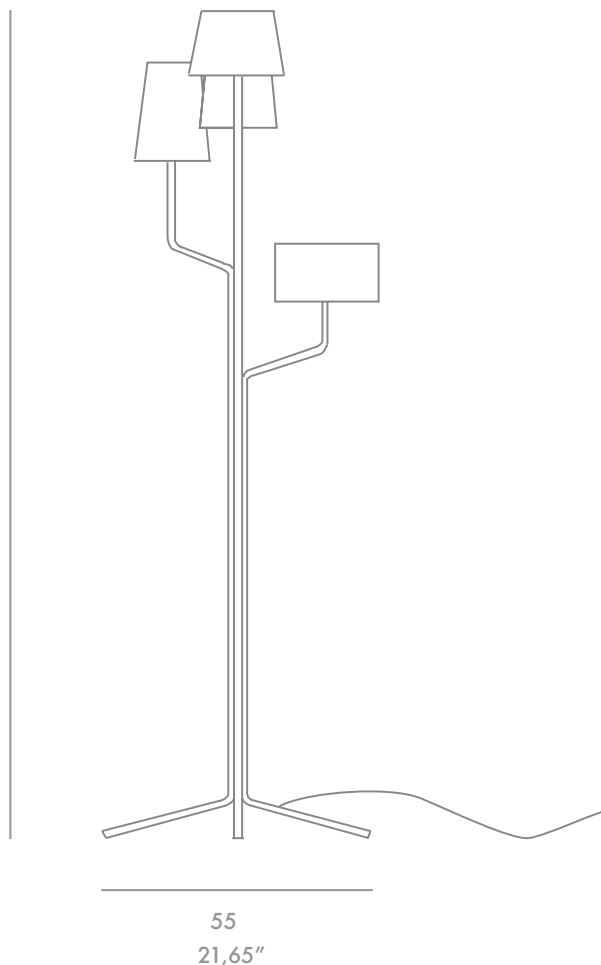

FABRIC LAMPSHADE (OPTIONAL)  
PANTALLAS TEXTILES (OPCIONAL)



BLACK  
NEGRO



RED  
ROJO



WHITE  
BLANCO

Lighting for domestic use.

Do not store or keep under extreme temperatures during long periods of time.

Do not handle the electrical material more than the necessary for installation of the fixture.

The installation must be done by specialized technical team.

Do not use bulbs with superior voltage as recommended by the manufacture.

For its cleaning, use only a soft cloth moistened with a mild soap solution. Do not use ammonia products, solvents or abrasives.

Do not use products such as air freshener that may contain alcoholic base.

Iluminación para uso doméstico.

No almacenar ni exponer a condiciones extremas de humedad o durante periodos prolongados.

No manipular el material eléctrico de la luminaria más allá del especificado para su montaje.

La instalación debe realizarse por personal técnico especializado.

No utilizar bombillas de potencia superior a la recomendada por el fabricante.

Para su limpieza, utilizar un paño suave ligeramente humedecido con una solución jabonosa.

No utilizar productos amoniacales, disolventes ni abrasivos. No pulverizar directamente, ni arrojar sobre la superficie productos ambientales y/o de base alcohólica.



WALL LAMP APLIQUE

MATERIAL: Brass

MATERIAL: Latón

LED  
E14 7W x 3 units

WEIGHT PESO: 6 KG  
Package size: 0,42 x 0,42 x 0,41

FINISHES  
ACABADOS

LAQUERED  
LACADOS



BLACK  
NEGRO



WHITE  
BLANCO



SLATE BLUE  
AZUL PIZARRA

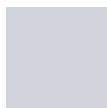

FOG BLUE  
AZUL NIEBLA



GREY GREEN  
VERDE GRIS



SOFT GREEN  
VERDE SOFT



BURGUNDY  
BORGOÑA



CORAL PINK  
ROSA CORAL



PASTEL BLUE  
AZUL PASTEL

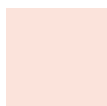

QUARTZ PINK  
ROSA QUARZO

FABRIC LAMPSHADE (OPTIONAL)  
PANTALLAS TEXTILES (OPCIONAL)



BLACK  
NEGRO



RED  
ROJO



WHITE  
BLANCO

43  
16,9"

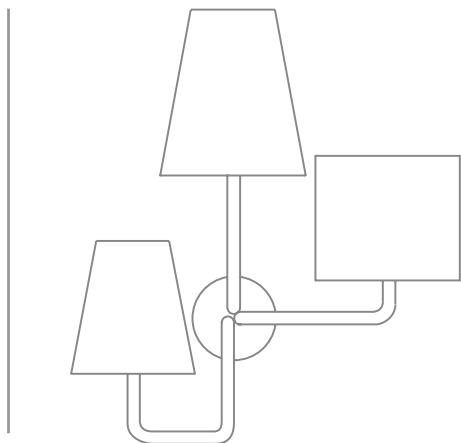

37  
14,5"

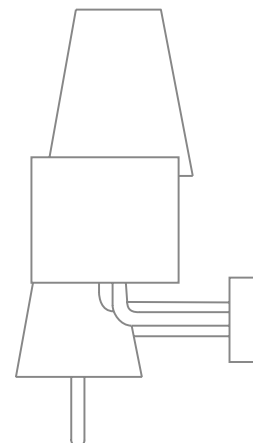

12  
4,72"

Lighting for domestic use.

Do not store or keep under extreme temperatures during long periods of time.

Do not handle the electrical material more than the necessary for installation of the fixture.

The installation must be done by specialized technical team.

Do not use bulbs with superior voltage as recommended by the manufacture.

For its cleaning, use only a soft cloth moistened with a mild soap solution. Do not use ammonia products, solvents or abrasives.

Do not use products such as air freshener that may contain alcoholic base.

Iluminación para uso doméstico.

No almacenar ni exponer a condiciones extremas de humedad o durante periodos prolongados.

No manipular el material eléctrico de la luminaria más allá del especificado para su montaje.

La instalación debe realizarse por personal técnico especializado.

No utilizar bombillas de potencia superior a la recomendada por el fabricante.

Para su limpieza, utilizar un paño suave ligeramente humedecido con una solución jabonosa.

No utilizar productos amoniacales, disolventes ni abrasivos. No pulverizar directamente, ni arrojar sobre la superficie productos ambientales y/o de base alcohólica.