

HANGING LAMP COLGANTE



MATERIAL: Rotational moulded polymer diffusers and brass structure.

MATERIAL: Difusor de polimero por rotomoldeo y estructura de latón

LED

E27 7W 360° x 18 units

WEIGHT PESO: 28 KG

Package size: 1,14 x 1,14 x 1,14

FINISHES

ACABADOS

LAQUERED

LACADOS



BLACK
NEGRO



WHITE
BLANCO



SLATE BLUE
AZUL PIZARRA

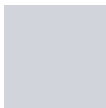

FOG BLUE
AZUL NIEBLA



GREY GREEN
VERDE GRIS



SOFT GREEN
VERDE SOFT



BURGUNDY
BORGONA



CORAL PINK
ROSA CORAL



PASTEL BLUE
AZUL PASTEL

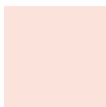

QUARTZ PINK
ROSA QUARZO

METALLIC

METÁLICOS



CHROME
CROMADO



GLAZED NICKEL
NIQUEL MATE



GOLD
ORO



COPPER
COBRE

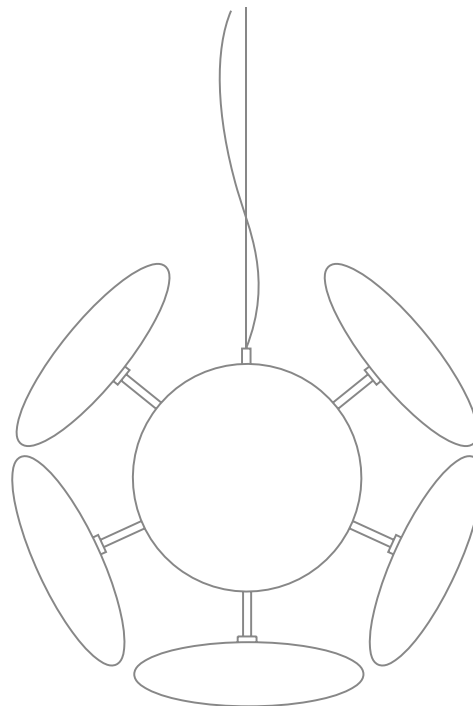

103
40"

100
39,4"

Lighting for domestic use.

Do not store or keep under extreme temperatures during long periods of time.

Do not handle the electrical material more than the necessary for installation of the fixture.

The installation must be done by specialized technical team.

Do not use bulbs with superior voltage as recommended by the manufacture.

For its cleaning, use only a soft cloth moistened with a mild soap solution. Do not use ammonia products, solvents or abrasives.

Do not use products such as air freshener that may contain alcoholic base.

Iluminación para uso doméstico.

No almacenar ni exponer a condiciones extremas de humedad o durante periodos prolongados.

No manipular el material eléctrico de la luminaria más allá del especificado para su montaje.

La instalación debe realizarse por personal técnico especializado.

No utilizar bombillas de potencia superior a la recomendada por el fabricante.

Para su limpieza, utilizar un paño suave ligeramente humedecido con una solución jabonosa.

No utilizar productos amoniacales, disolventes ni abrasivos. No pulverizar directamente, ni arrojar sobre la superficie productos ambientales y/o de base alcohólica.

HANGING LAMP COLGANTE



MATERIAL: Rotational moulded polymer diffusers and brass structure.

MATERIAL: Difusor de polimero por rotomoldeo y estructura de latón

LED
E27 7W 360° x 34 units

FINISHES ACABADOS

LAQUERED LACADOS



BLACK
NEGRO



WHITE
BLANCO



SLATE BLUE
AZUL PIZARRA

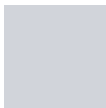

FOG BLUE
AZUL NIEBLA



GREY GREEN
VERDE GRIS



SOFT GREEN
VERDE SOFT



BURGUNDY
BORGONA



CORAL PINK
ROSA CORAL



PASTEL BLUE
AZUL PASTEL

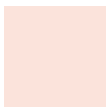

QUARTZ PINK
ROSA QUARZO

METALLIC METÁLICOS



CHROME
CROMADO



GLAZED NICKEL
NIQUEL MATE



GOLD
ORO



COPPER
COBRE

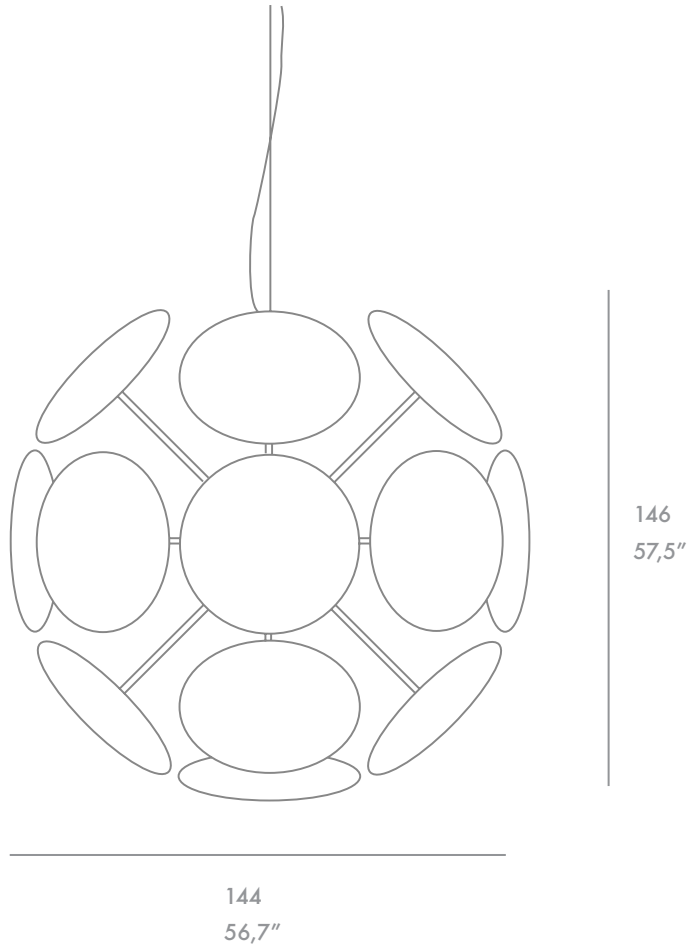

Lighting for domestic use.

Do not store or keep under extreme temperatures during long periods of time.

Do not handle the electrical material more than the necessary for installation of the fixture.

The installation must be done by specialized technical team.

Do not use bulbs with superior voltage as recommended by the manufacture.

For its cleaning, use only a soft cloth moistened with a mild soap solution. Do not use ammonia products, solvents or abrasives.

Do not use products such as air freshener that may contain alcoholic base.

Iluminación para uso doméstico.

No almacenar ni exponer a condiciones extremas de humedad o durante periodos prolongados.

No manipular el material eléctrico de la luminaria más allá del especificado para su montaje.

La instalación debe realizarse por personal técnico especializado.

No utilizar bombillas de potencia superior a la recomendada por el fabricante.

Para su limpieza, utilizar un paño suave ligeramente humedecido con una solución jabonosa.

No utilizar productos amoniacales, disolventes ni abrasivos. No pulverizar directamente, ni arrojar sobre la superficie productos ambientales y/o de base alcohólica.

TABLE LAMP SOBREMESA



MATERIAL: Rotational moulded polymer diffusers and brass structure.

MATERIAL: Difusor de polimero por rotomoldeo y estructura de latón

LED
E27 360° 7W x 2 units

WEIGHT PESO: 6 KG
Package size: 0,61 x 061 x 0,5

FINISHES ACABADOS

LAQUERED LACADOS



BLACK
NEGRO



WHITE
BLANCO



SLATE BLUE
AZUL PIZARRA

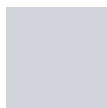

FOG BLUE
AZUL NIEBLA



GREY GREEN
VERDE GRIS



SOFT GREEN
VERDE SOFT



BURGUNDY
BORGONA



CORAL PINK
ROSA CORAL



PASTEL BLUE
AZUL PASTEL

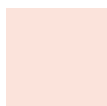

QUARTZ PINK
ROSA QUARZO

METALLIC METÁLICOS



CHROME
CROMADO



GLAZED NICKEL
NIQUEL MATE



GOLD
ORO



COPPER
COBRE

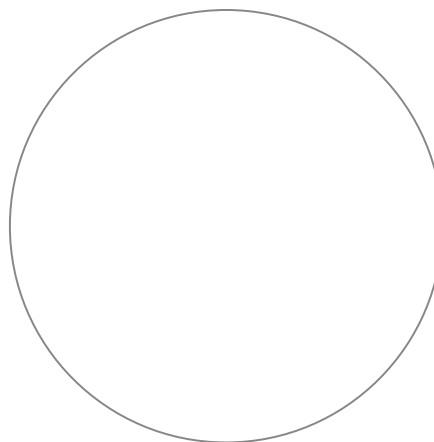

19,5
7,7"

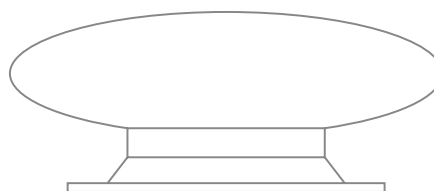

50
19,7"

Lighting for domestic use.

Do not store or keep under extreme temperatures during long periods of time.

Do not handle the electrical material more than the necessary for installation of the fixture.

The installation must be done by specialized technical team.

Do not use bulbs with superior voltage as recommended by the manufacture.

For its cleaning, use only a soft cloth moistened with a mild soap solution. Do not use ammonia products, solvents or abrasives.

Do not use products such as air freshener that may contain alcoholic base.

Iluminación para uso doméstico.

No almacenar ni exponer a condiciones extremas de humedad o durante periodos prolongados.

No manipular el material eléctrico de la luminaria más allá del especificado para su montaje.

La instalación debe realizarse por personal técnico especializado.

No utilizar bombillas de potencia superior a la recomendada por el fabricante.

Para su limpieza, utilizar un paño suave ligeramente humedecido con una solución jabonosa.

No utilizar productos amoniacales, disolventes ni abrasivos. No pulverizar directamente, ni arrojar sobre la superficie productos ambientales y/o de base alcohólica.



MATERIAL: Rotational moulded polymer diffusers and brass structure.

MATERIAL: Difusor de polímero por rotomoldeo y estructura de latón

LED
E27 7W 360° x 2 units

WEIGHT PESO: 12 KG
Package size: 0,61 x 0,61 x 0,45

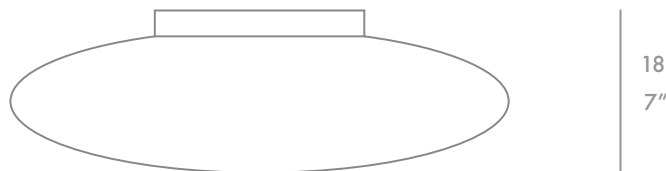

FINISHES ACABADOS

LAQUERED LACADOS



BLACK
NEGRO



WHITE
BLANCO



SLATE BLUE
AZUL PIZARRA

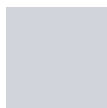

FOG BLUE
AZUL NIEBLA



GREY GREEN
VERDE GRIS



SOFT GREEN
VERDE SOFT



BURGUNDY
BORGONA



CORAL PINK
ROSA CORAL



PASTEL BLUE
AZUL PASTEL

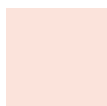

QUARTZ PINK
ROSA QUARZO

METALLIC METÁLICOS



CHROME
CROMADO



GLAZED NICKEL
NIQUEL MATE



GOLD
ORO



COPPER
COBRE

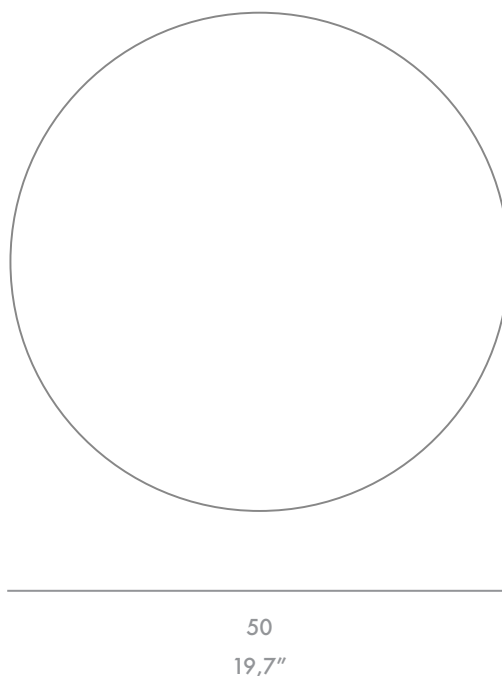

Lighting for domestic use.

Do not store or keep under extreme temperatures during long periods of time.

Do not handle the electrical material more than the necessary for installation of the fixture.

The installation must be done by specialized technical team.

Do not use bulbs with superior voltage as recommended by the manufacture.

For its cleaning, use only a soft cloth moistened with a mild soap solution. Do not use ammonia products, solvents or abrasives.

Do not use products such as air freshener that may contain alcoholic base.

Iluminación para uso doméstico.

No almacenar ni exponer a condiciones extremas de humedad o durante periodos prolongados.

No manipular el material eléctrico de la luminaria más allá del especificado para su montaje.

La instalación debe realizarse por personal técnico especializado.

No utilizar bombillas de potencia superior a la recomendada por el fabricante.

Para su limpieza, utilizar un paño suave ligeramente humedecido con una solución jabonosa.

No utilizar productos amoniacales, disolventes ni abrasivos. No pulverizar directamente, ni arrojar sobre la superficie productos ambientales y/o de base alcohólica.